

# LISTA DE SPARES



MANASSIST - Manutenção e Reparação de Portas, Lda.



---

**Notas:**





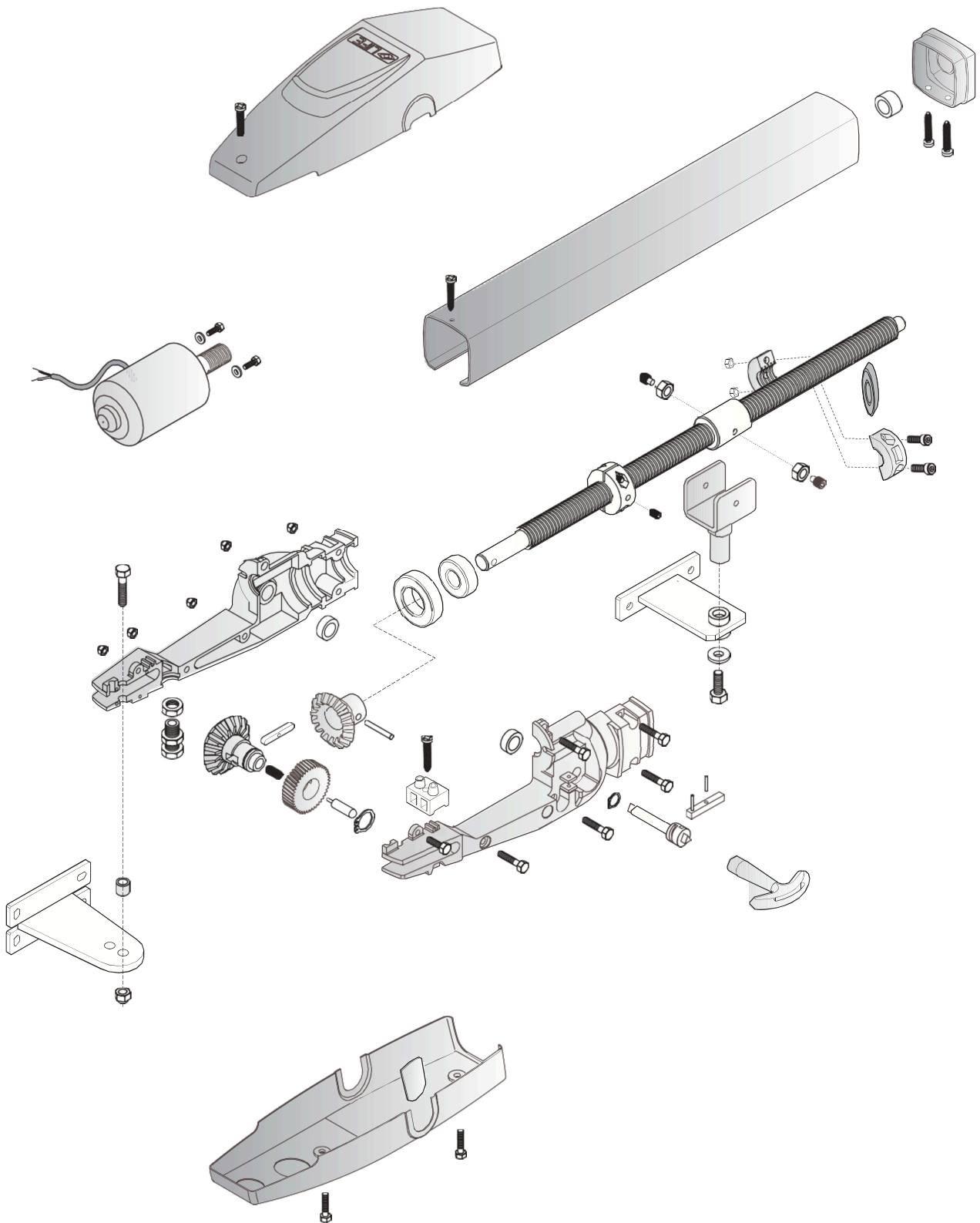

# INDICE

	Pág.
OP2 24 UNI	4
OP3 - OP5	6
ACER	10
ERGO	14
SUPRA	18
VIS	22
SINUO	24
OPTIMO SKY LINE	26
ARMOR	28
PLUS	30
PROBO	34
GEUNIR – GEUNIRS DL – GE2R	38
GE1A - GE2A	40
GEUNI24R DL – GEUNI24R DL1	42
GE1A 24 - GE2A 24	44

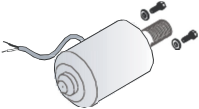

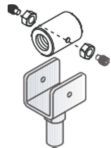
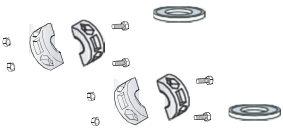

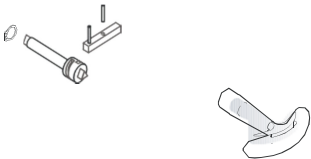
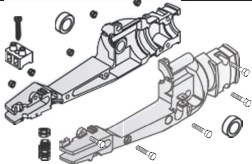
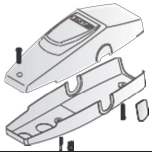
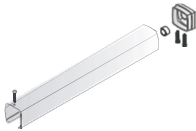
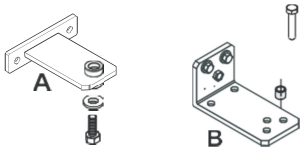

# OP24 UNI

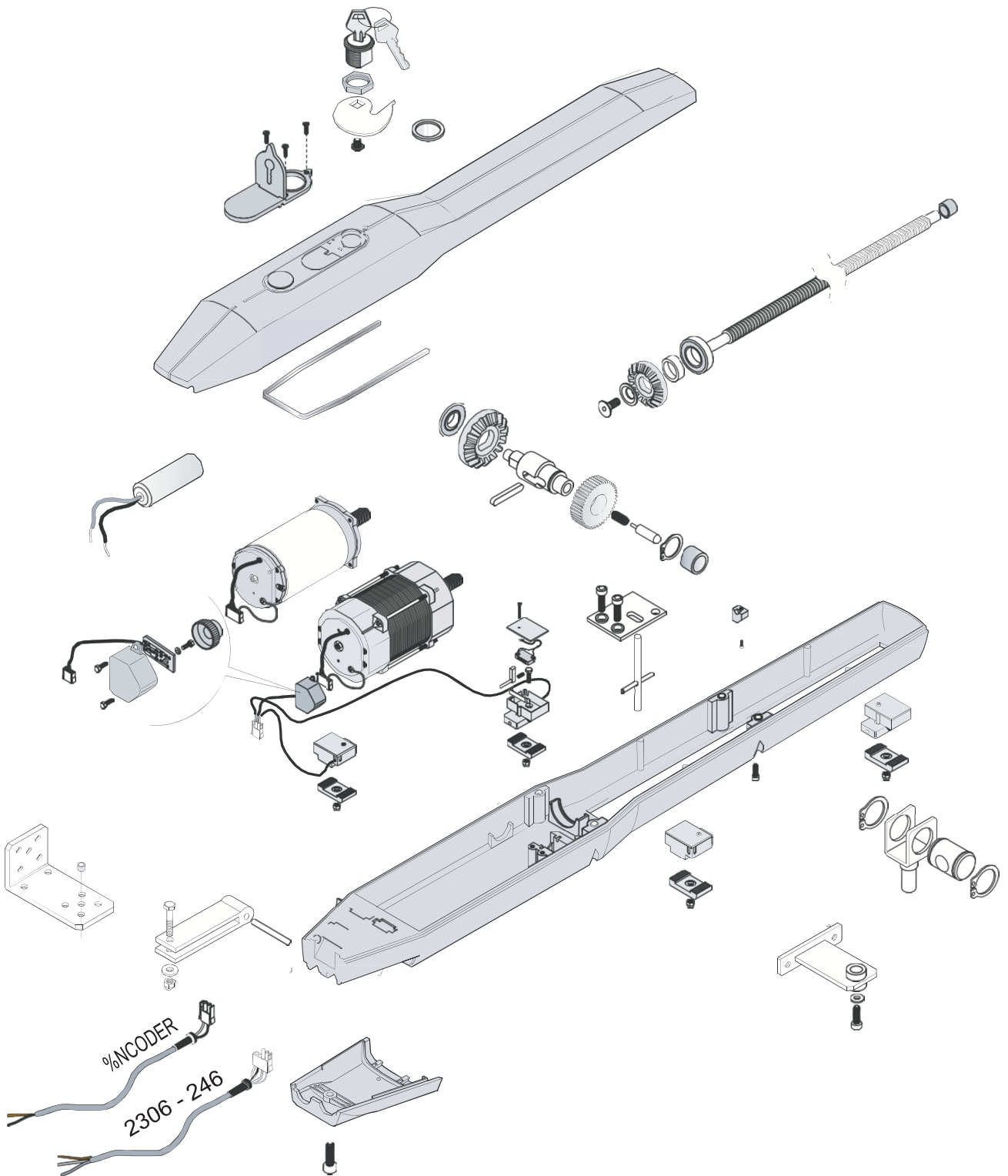

	<b>5RI1700000</b>	
	<b>5RI1710000</b>	
	<b>5RI1720000</b>	
	<b>5RI1730000</b>	
	<b>5RI1740000</b>	
	<b>5RI1750000</b> <b>5RI2760000</b>	
	<b>5RI1760000</b>	
	<b>5RI1770000</b>	
	<b>5RI1780000</b>	
	<b>5RI1790000 A</b> <b>5RI1800000 B</b>	
	<b>5RI3530000</b>	

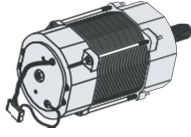
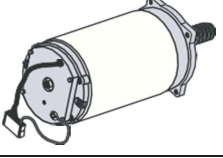
# OPTIMO OP3 – OP5

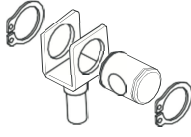
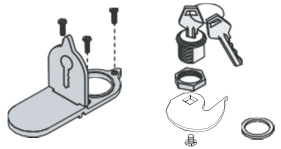
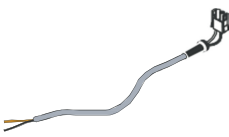
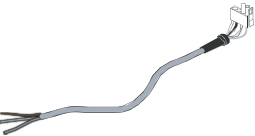
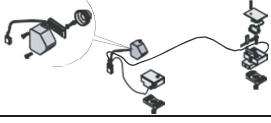
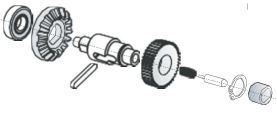

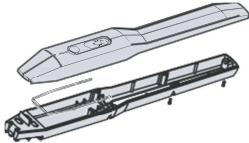

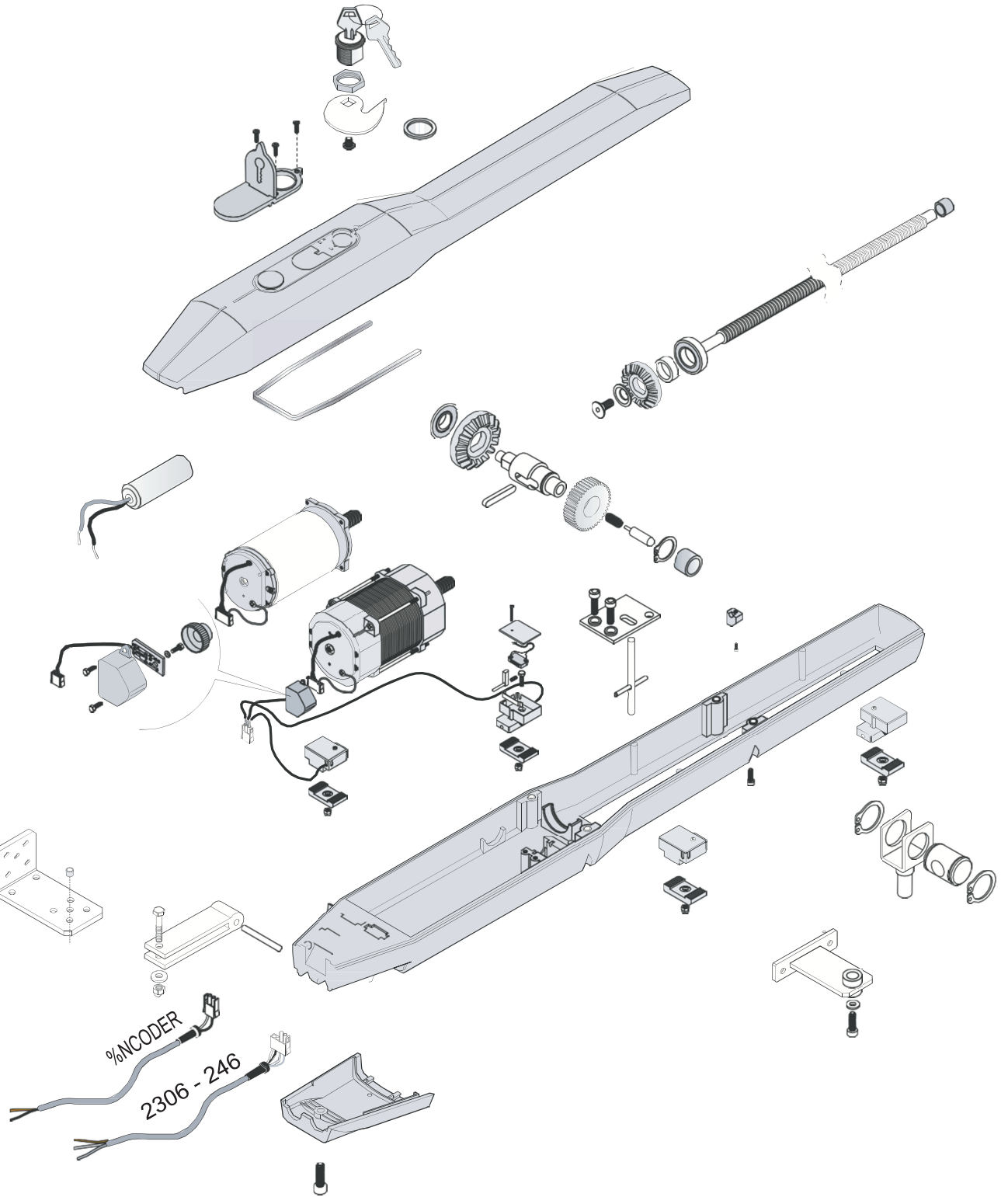
	<b>5RI0870000</b> OP3-OP5-OP3UNI,-OP5UNI <b>5RI0880000</b> OP3L-OP3LUNI-OP5L-OP5LUNI	
	<b>5RI0890000</b> OP324-OP324UNI-OP524-OP524UNI	
	<b>5RI0900000</b> OP3-OP3UNI,-OP3L-OP3LUNI-OP324-OP324UNI <b>5RI0910000</b> OP5-OP5UNI-OP5L-OP5LUNI-OP524-OP524UNI	
	<b>5RI0920000</b>	
	<b>5RI0930000</b>	
	<b>5RI0940000 Encoder</b> OP3-OP3L-OP5-OP5L-OP324-OP524	
	<b>55RI950000 230V</b> O3-OP3L-OP3UNI-OP3LUNI-OP5- OP5L-OP5UNI-OP5LUNI <b>5RI0960000 24V</b> OP324-OP324UNI-OP524-OP524UNI	
	<b>5RI0970000</b> OP3-OP3L-OP324 <b>5RI0980000</b> OP5-OP5L-OP524	
	<b>5RI0990000</b>	
	<b>5RI1000000</b>	
	<b>5RI1010000</b> OP3-OP3L-OP324 <b>5RI1020000</b> OP5-OP5L-OP524	





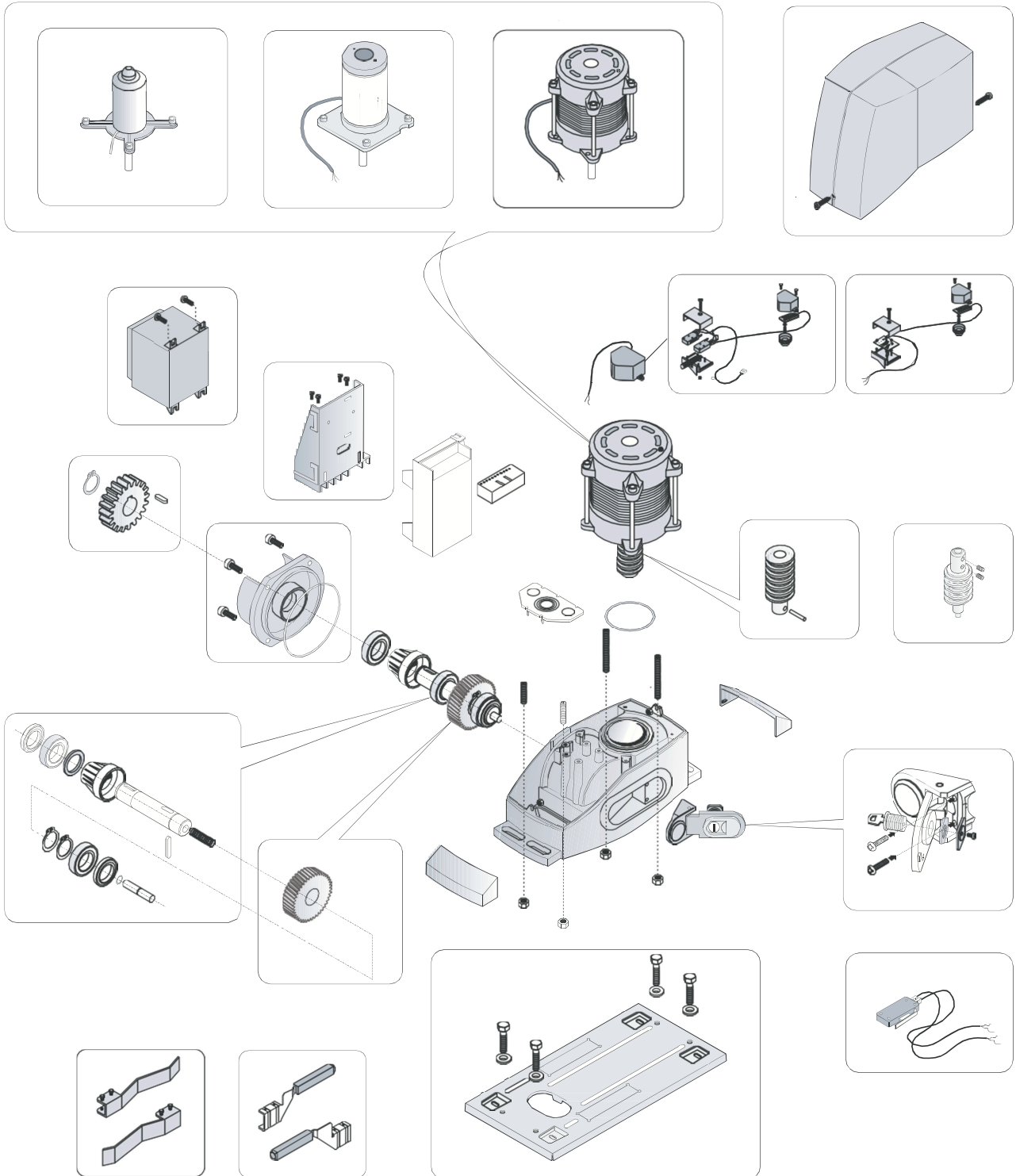

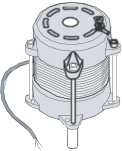
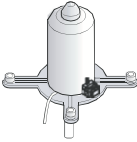
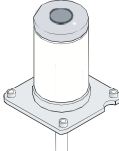
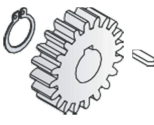
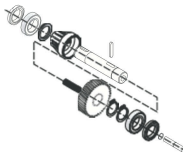
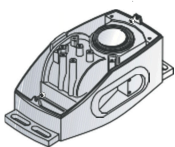
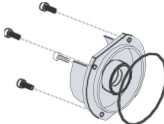
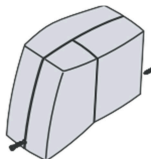
	<p><b>5RI1030000</b></p>	
	<p><b>5RI1040000</b></p>	
	<p><b>5RI1060000</b></p>	
	<p><b>5RI1070000</b></p>	
	<p><b>5RI1080000</b></p>	
	<p><b>5RI2750000</b></p>	

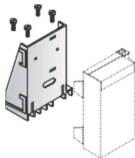
# ACER

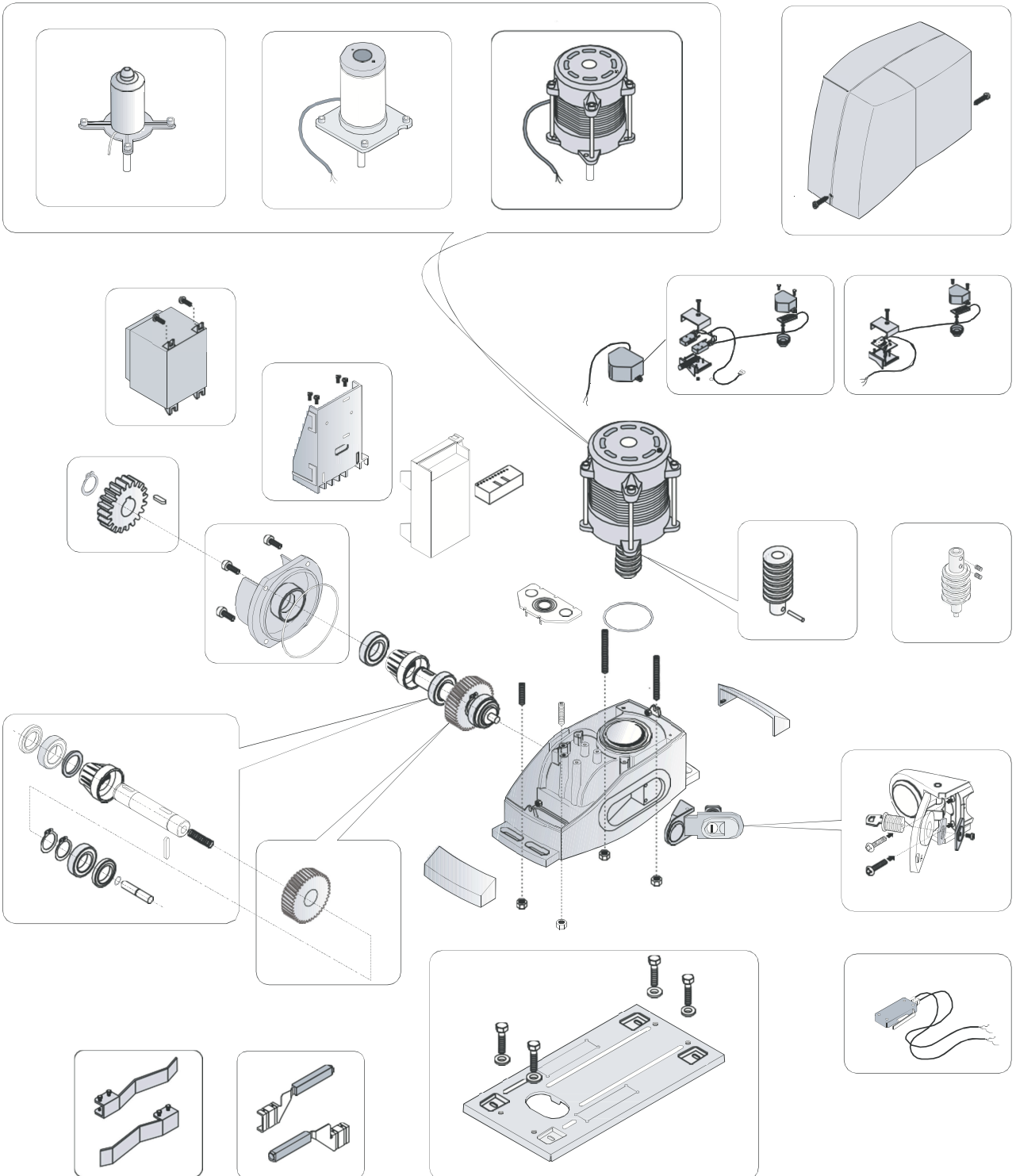

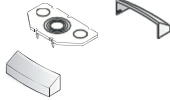

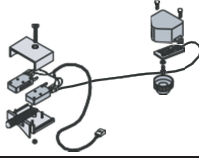
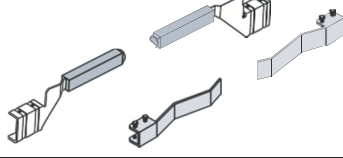
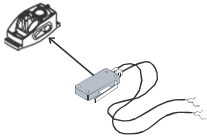
	<b>5RI2420000</b> AC4-AC4R <b>5RI2430000</b> AC6-AC6R <b>5RI2410000</b> AC8-AC8R <b>5RI3440000</b> AC12-AC12R	
	<b>5RI2440001</b> AC3RM24 DL	
	<b>5RI2450000</b> AC4 24 <b>5RI2460000</b> AC6 24 <b>5RI2470000</b> AC8 24 <b>5RI3450000</b> AC6RM24 DL	
	<b>5RI2550000</b> AC8-AC4 24-AC6 24-AC8 24 AC6-AC12-AC12R- AC3RM24DL/-AC6-AC6R <b>5RI2560000</b> AC4-AC4R	
	<b>5RI2570000</b>	
	<b>5RI2500000</b> ACER	
	<b>5RI2510000</b> AC4-AC4R <b>5RI2520000</b> AC8-AC4 24-AC6 24-AC8 24 AC324RMDL-AC6RM24DL-AC6-AC6R	
	<b>5RI2530000</b> ACER	
	<b>5RI2600000</b> AC4-AC6-AC4R-AC6R- AC4A24-AC6A24-AC6RM24DL/ <b>5RI2610000</b> AC3RM24DL/ <b>5RI2620000</b> AC824 <b>5RI1930000</b> AC8-AC12-AC8R-AC12R	
	<b>5RI2630000</b> AC4-AC6-AC8-AC8R-AC4R- AC4 24-AC6 24-AC6R-AC6RM24SL AC12-AC12R <b>5RI2640000</b> AC8A24-AC8A24M <b>5RI2650000</b> AC3RM24DL/	
	<b>5RI2580000</b>	

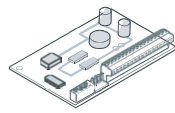
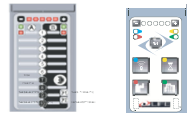



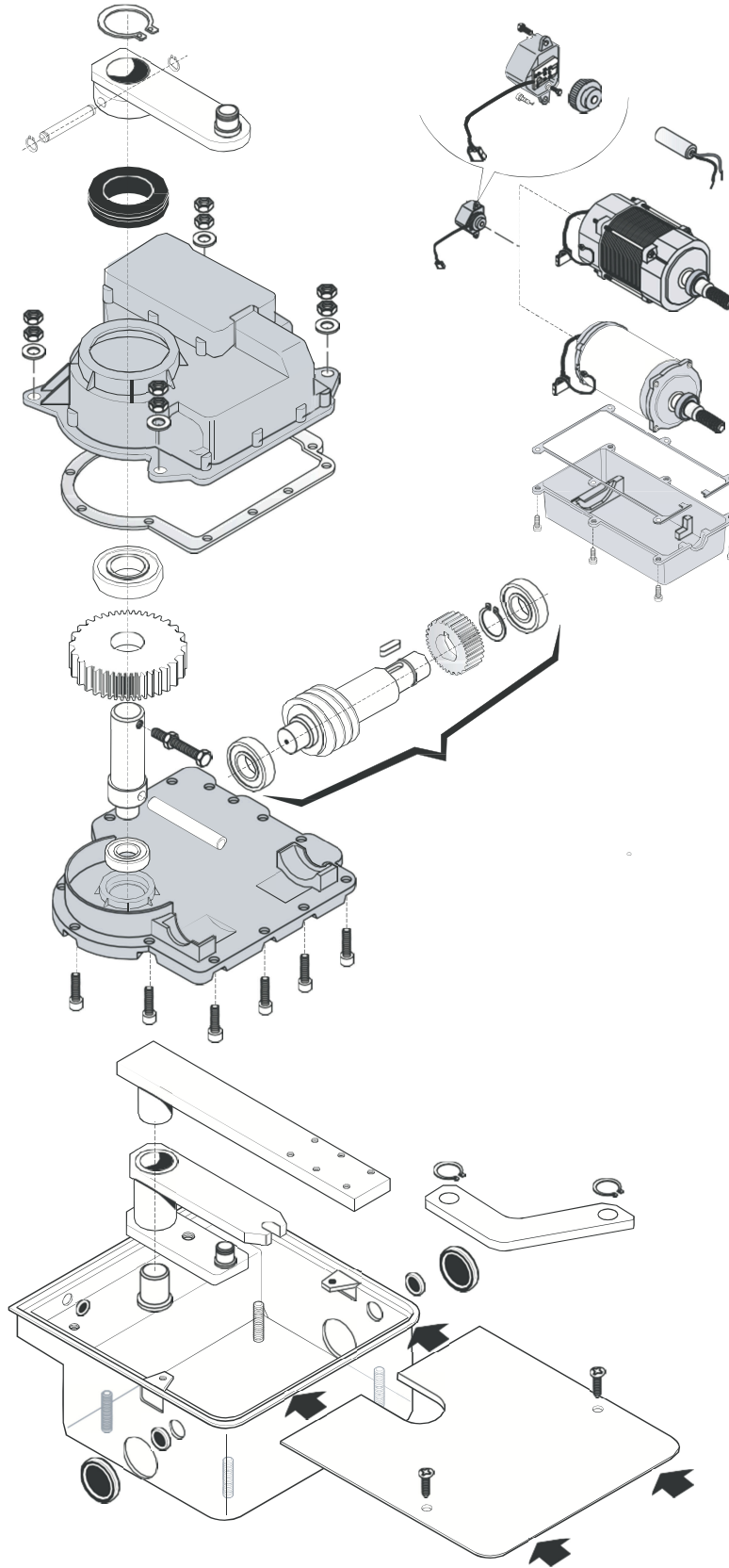

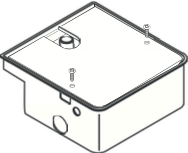
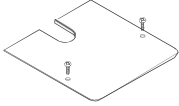
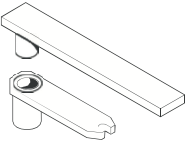
	<b>5RI2590000</b>	
	<b>5RI2310000</b>	
	<b>5RI2330000</b> AC4R-AC6R-AC4-AC6-AC8-AC12-AC12R <b>5RI2350000</b> AC8 24	
	<b>5RI2370000</b> AC4RM-AC6RM-AC4M AC6M-AC8M-AC12M-AC12RM <b>5RI2380000</b> AC8A24M <b>5RI2340001</b> AC3RM24 DL-AC6RM24DL	
	<b>5RI2480000</b> ACER R <b>5RI2490000</b> ACER RM	
	<b>5RI2670000</b> ACER	
	<b>5RI2680000</b> ACER <b>5RI2680001</b> ACER SIMPLY	
	<b>5RI2690000</b> AC4-AC6-AC8-AC12 <b>5RI2700000</b> AC4A 24-AC6A 24 <b>5RI2720000</b> AC8A 24-AC3/6RM24DL <b>5RI2730000</b> AC4R-AC6R-AC8R-AC12R	
	<b>5RI1960001</b> AC4-AC6 <b>5RI1960000</b> AC8-AC12	
	<b>RG1A</b> ACER AC4 - AC6 -AC8 -AC12 <b>RG1R</b> ACER R5 <b>RG1R DL</b> ACER DL <b>RG1R 24 DL</b> AC&3RM 24 DL <b>RG1A 24</b> AC8A 24	
	<b>1AH0010000</b> AGEM 1 <b>1AH0180000</b> AGEM DL	

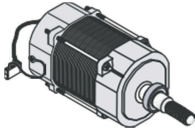
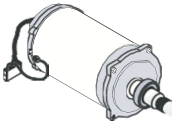
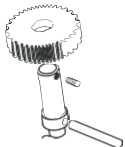
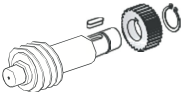
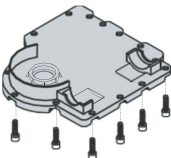
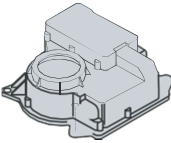
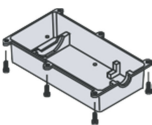
# ERGO

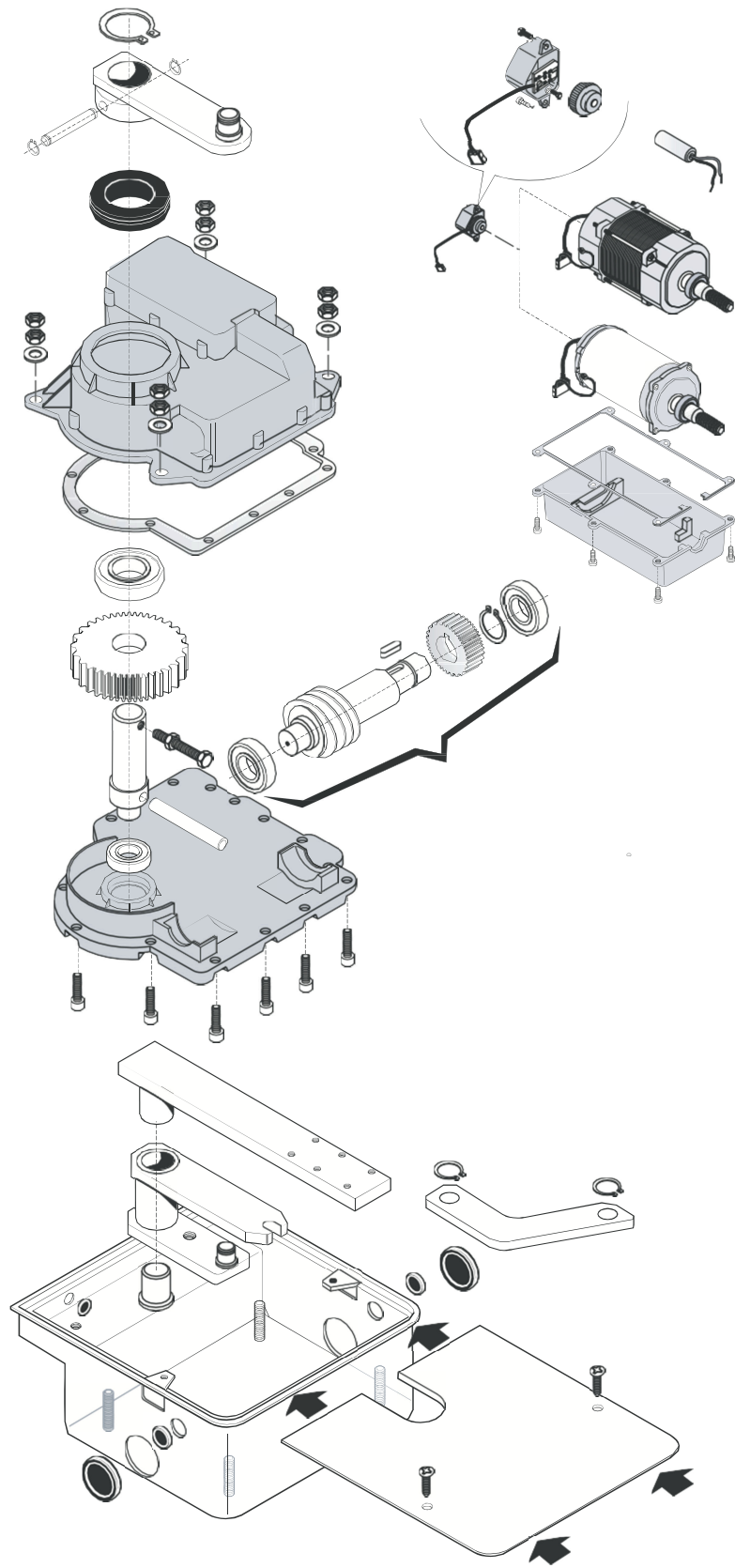

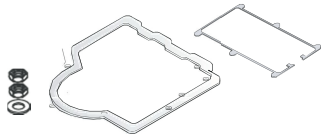

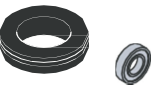
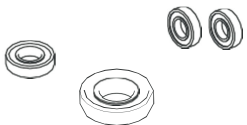



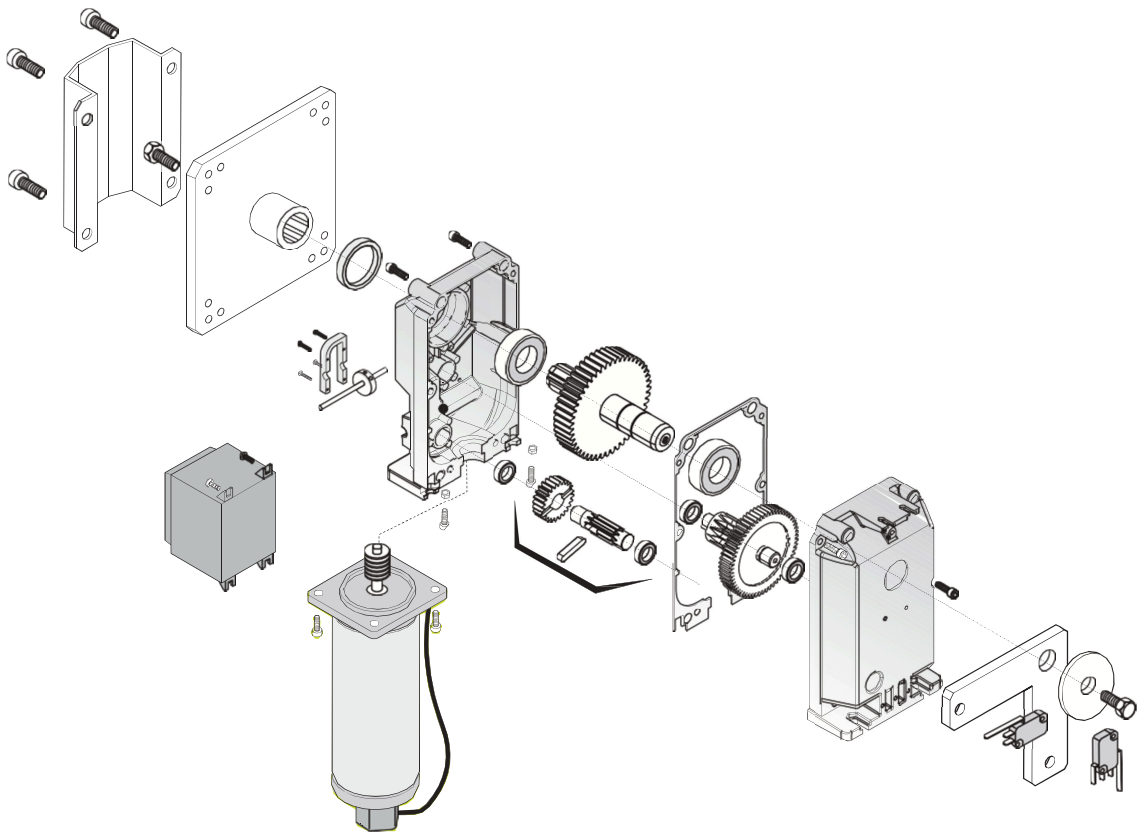
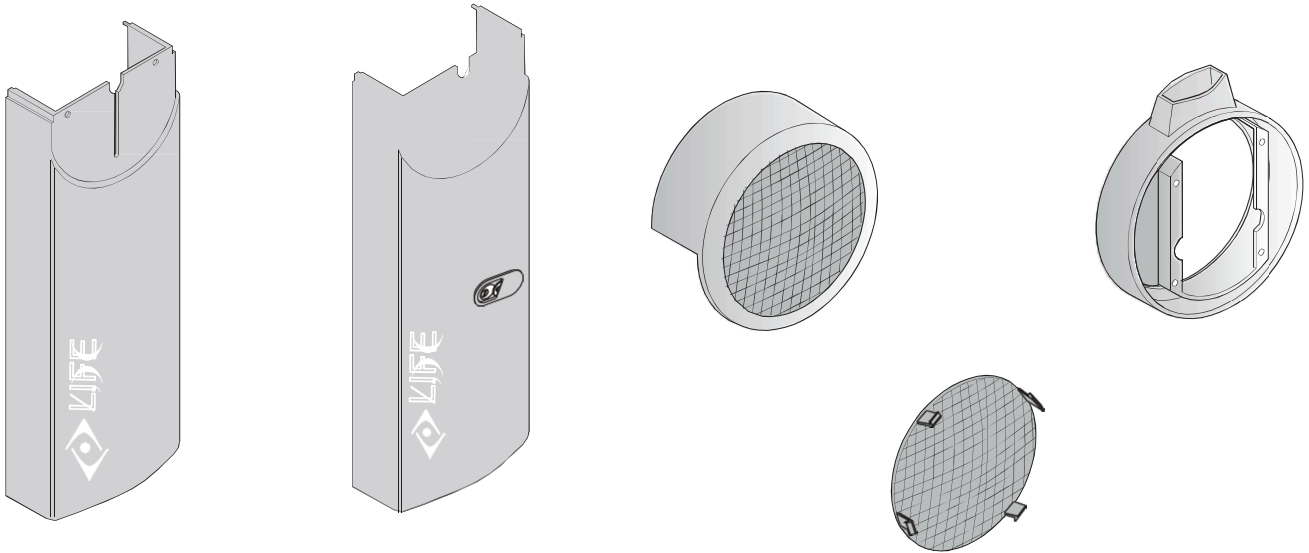

	<b>1AM0820000</b> ERG <b>1AM0830000</b> ERGX	
	<b>5RI3200000</b> ERGX <b>5RI3210000</b> ER	
	<b>5RI0520000</b>	
	<b>5RI0530000</b>	
	<b>5RI0660000</b> ER4 / ER4UNI / ER4B <b>5RI0670000</b> ER4L / ER4UNL	
	<b>5RI0680000</b>	
	<b>5RI0630000</b>	
	<b>5RI0650000</b>	
	<b>5RI0540000</b>	
	<b>5RI0580000</b> <b>5RI0590000</b> <b>5RI0600000</b>	
	<b>5RI0620000</b>	

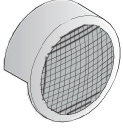

	<p><b>5RI3220000</b></p>	
	<p><b>5RI0610000</b></p>	
	<p><b>5RI0570000</b></p>	
	<p><b>5RI3470000</b></p>	
	<p><b>5RI0640000</b></p>	

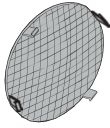
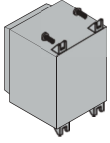
# SUPRA

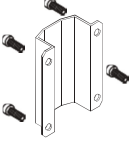
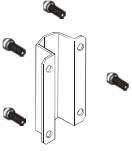

	<b>5RI2250000</b>	
	<b>5RI2240000</b>	
	<b>5RI2260000</b>	
	<b>5RI2270000</b>	
	<b>5RI2280000</b>	
	<b>5RI2690000</b>	
	<b>5RI3090000</b>	
	<b>5RI2810000</b>	
	<b>5RI2810001</b>	
	<b>5RI2140000</b>	
	<b>5RI3130000</b>	

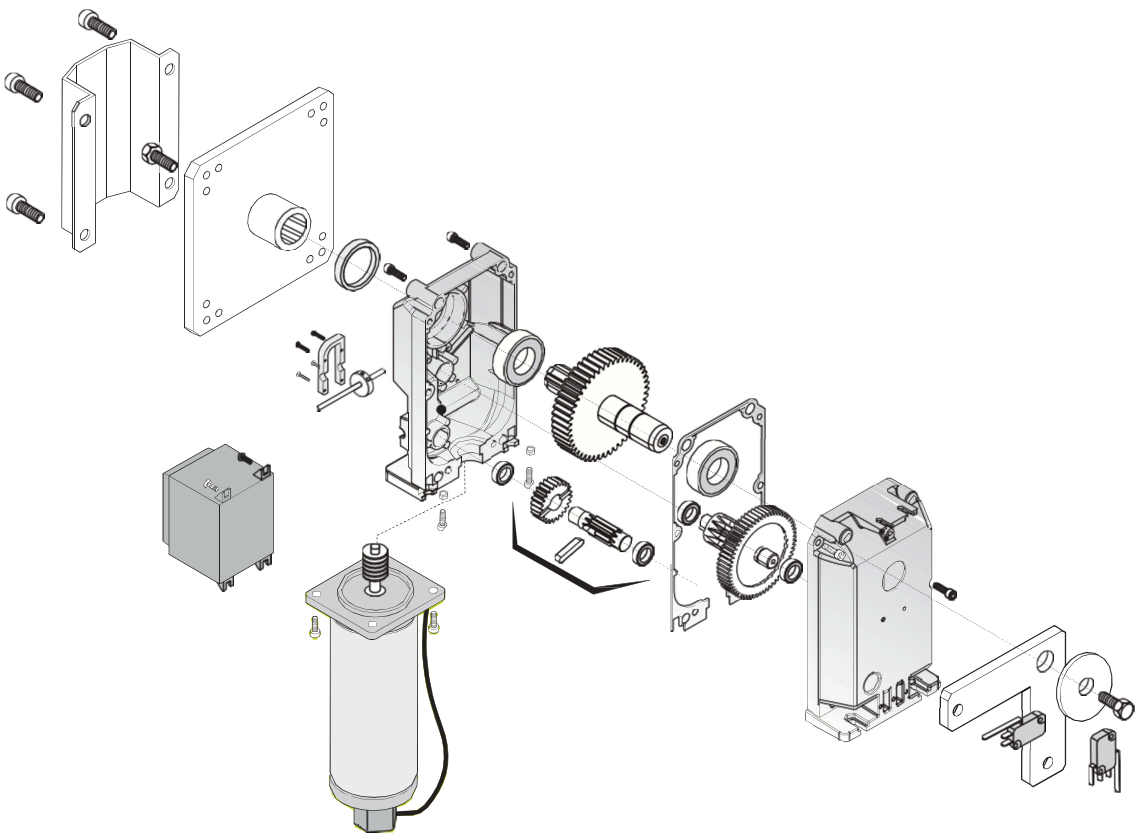
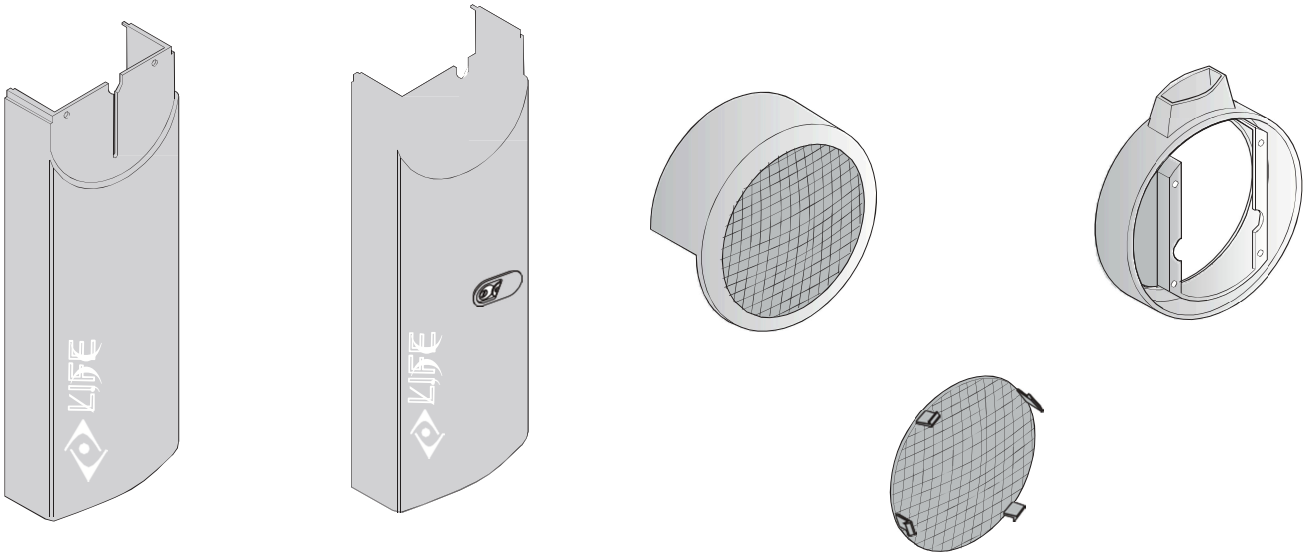

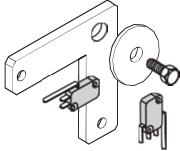
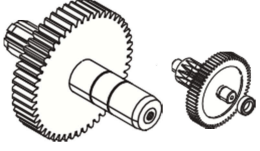
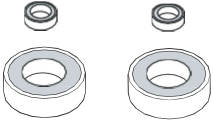
	<p><b>5RI3120000</b></p>	
	<p><b>5RI3140000</b></p>	
	<p><b>5RI3150000</b></p>	
	<p><b>5RI3160000</b></p>	
	<p><b>5RI3480000</b></p>	
	<p><b>5RI3490000</b></p>	

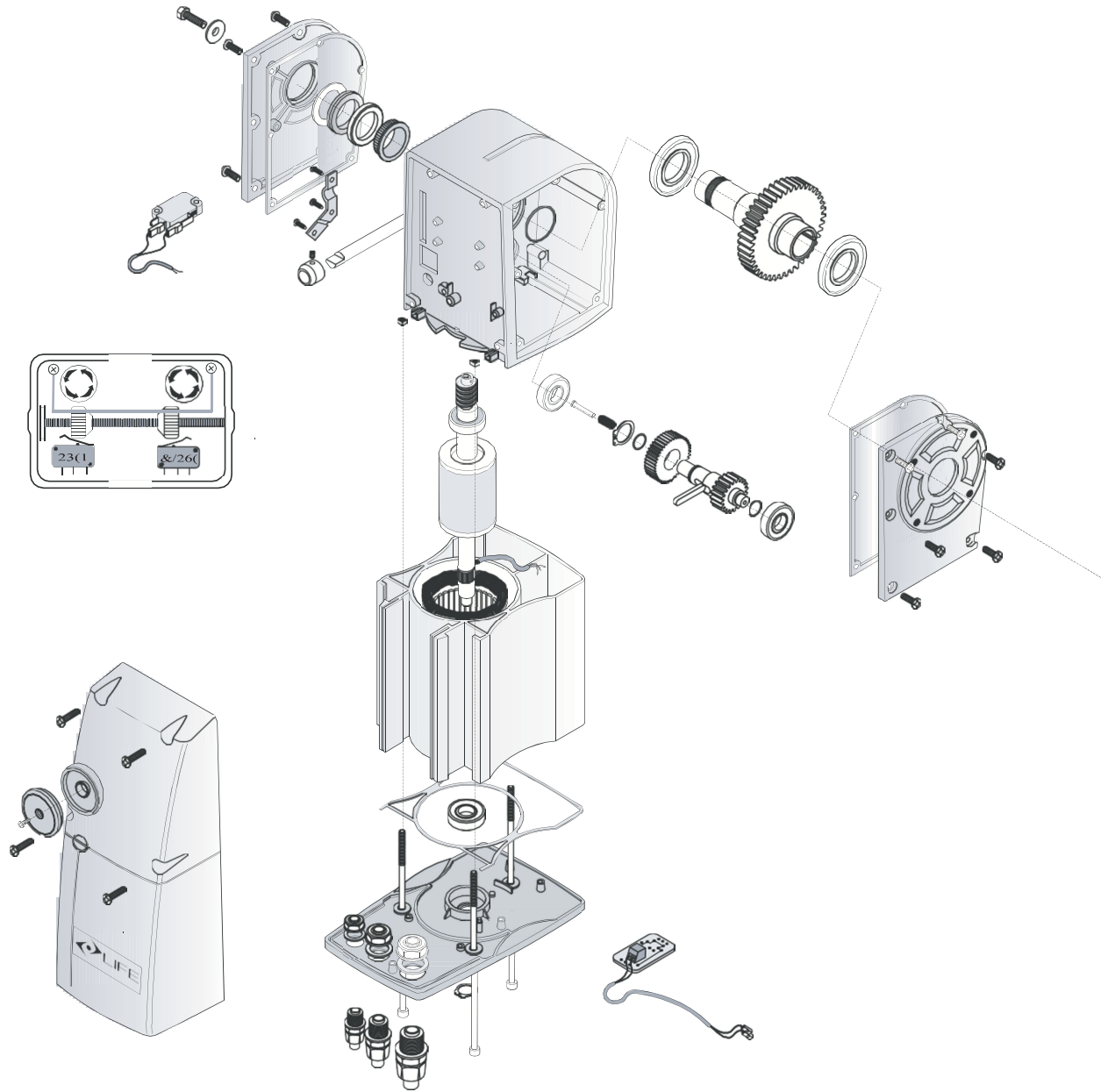

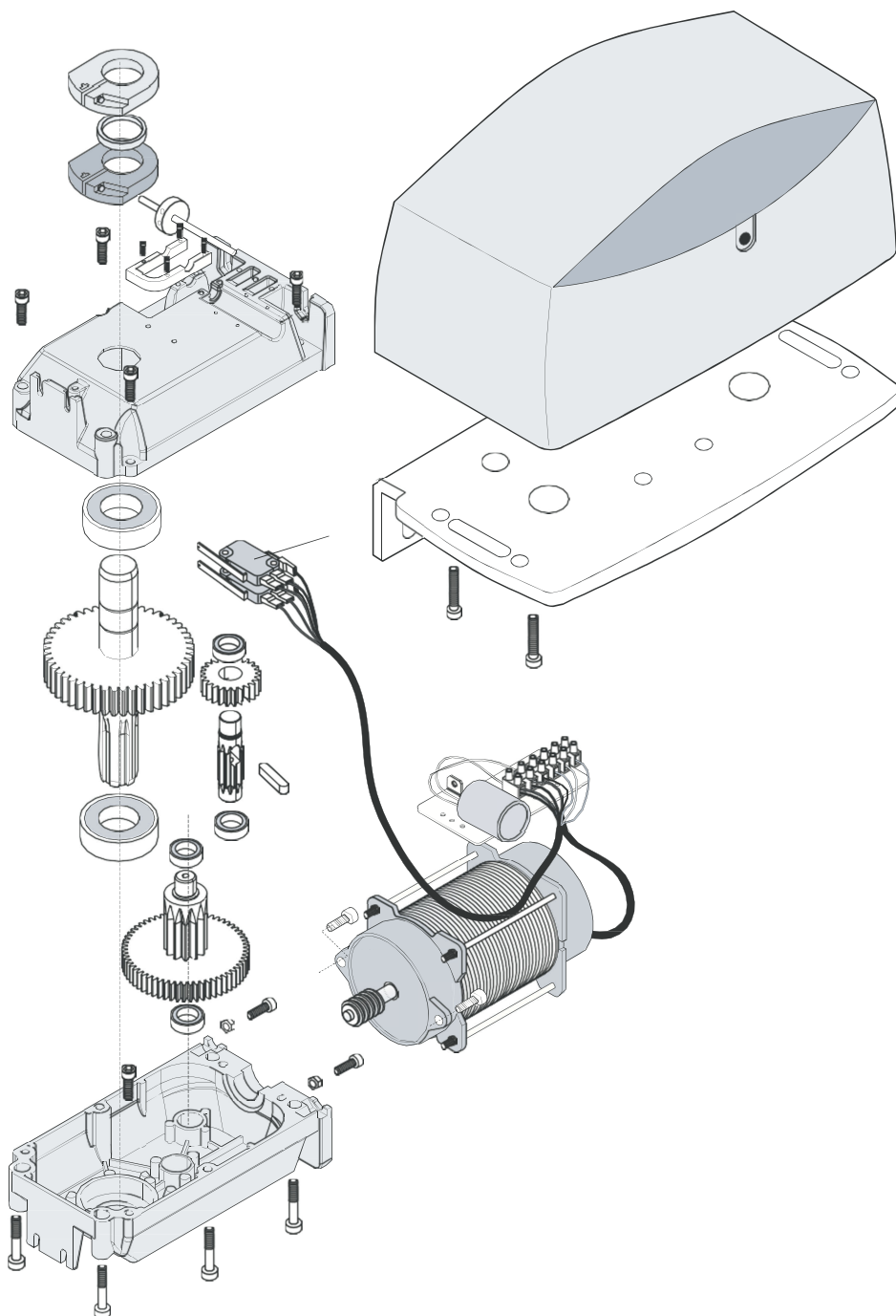

	<b>5RI3050000</b>	
	<b>5RI</b>	
	<b>5RI</b>	
	<b>5RI3080000</b>	
	<b>5RI3060000</b>	
	<b>5RI</b>	
	<b>5RI3070000</b>	
	<b>5RI3020000</b>	
	<b>5RI3040000</b>	
	<b>5RI3030000</b>	
	<b>5RI3010000</b>	

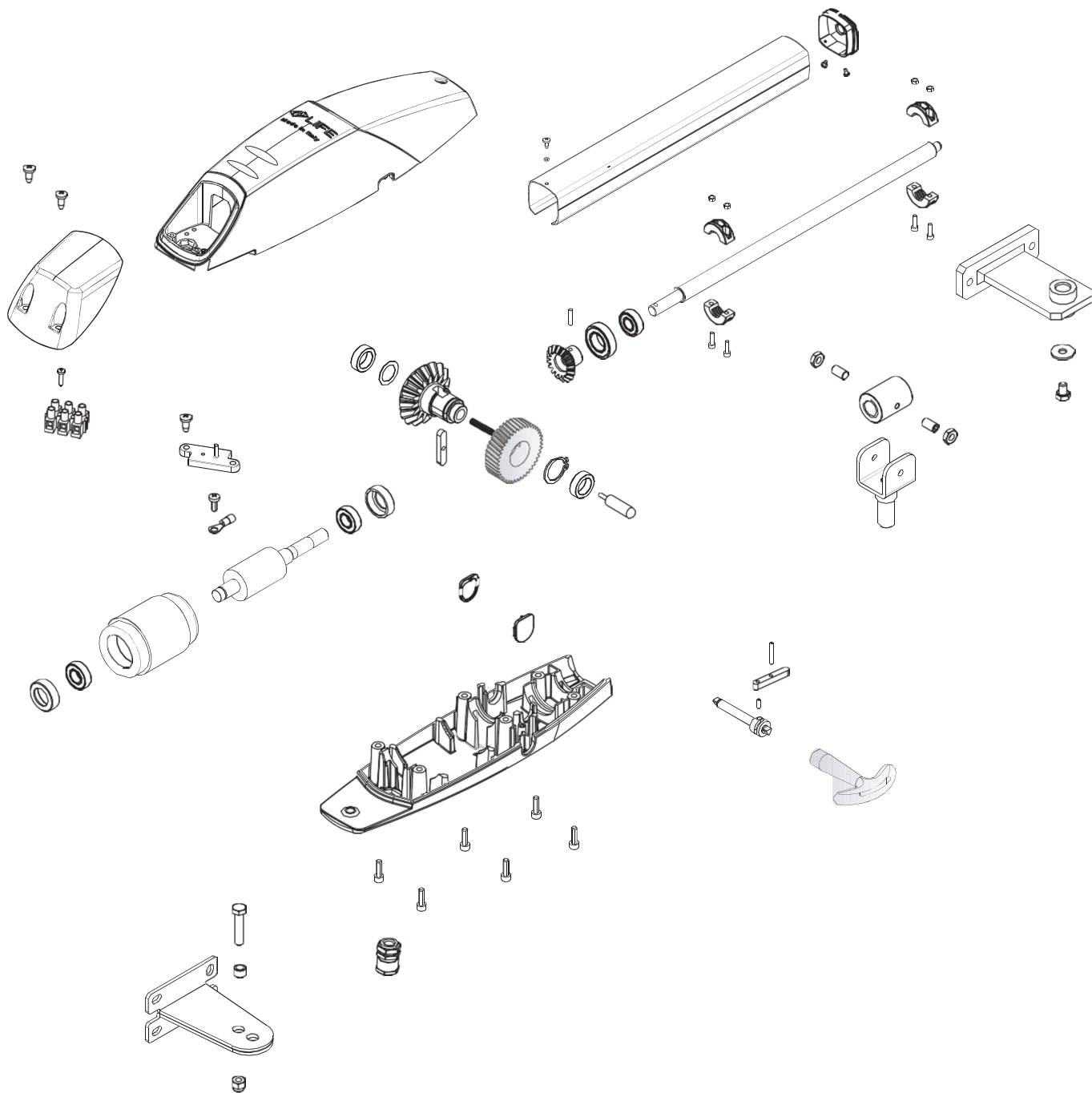

	<b>5RI3230000</b>	
	<b>5RI3240000</b>	
	<b>5RI3250001</b> SIN3 <b>5RI3250000</b> SIN5	
	<b>5RI3260000</b>	
	<b>5RI3270000</b>	
	<b>5RI3280000</b>	
	<b>5RI3290000</b>	
	<b>5RI3300000</b>	
	<b>5RI3310000</b>	
	<b>5RI3320000</b>	
	<b>5RI3330000</b>	

# OPTIMO SKY LINE

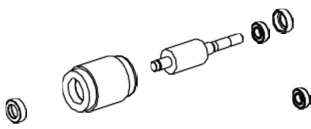
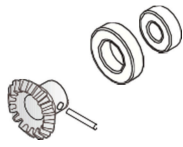
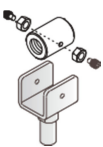
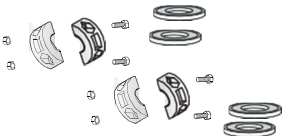
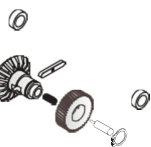
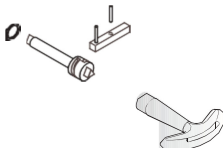
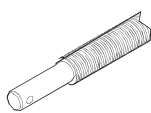
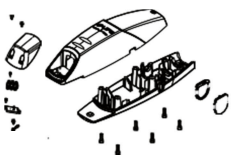

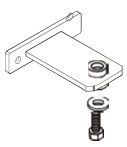
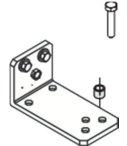
	<b>5RI350000</b>	
	<b>5RI1710000</b>	
	<b>5RI1720000</b>	
	<b>5RI3510000</b>	
	<b>5RI3520000</b>	
	<b>5RI1750000</b>	
	<b>5RI3530000</b>	
	<b>5RI3540000</b>	
	<b>5RI1780001</b>	
	<b>5RI1790000</b>	
	<b>5RI1800000</b>	

# ARMOR

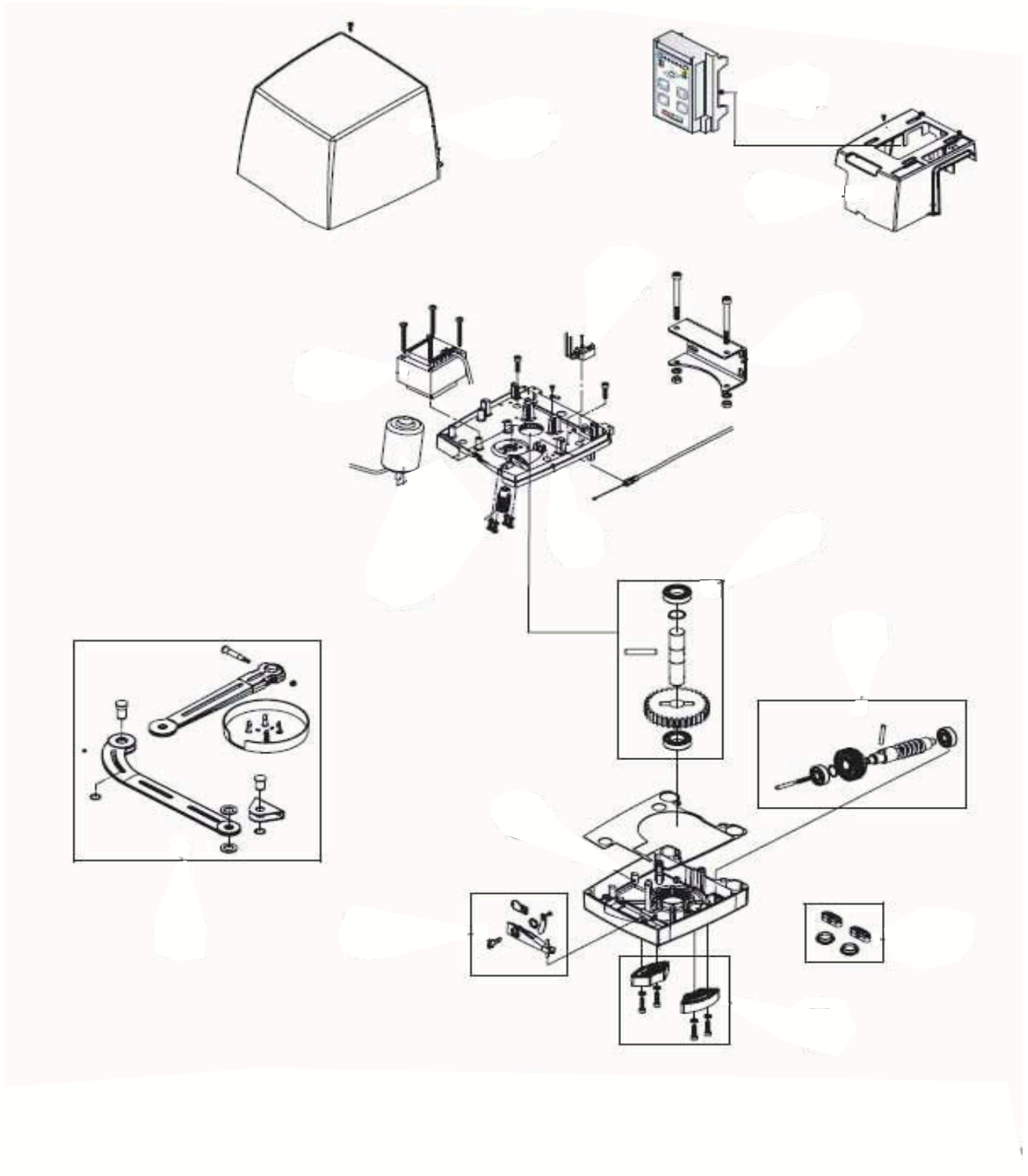





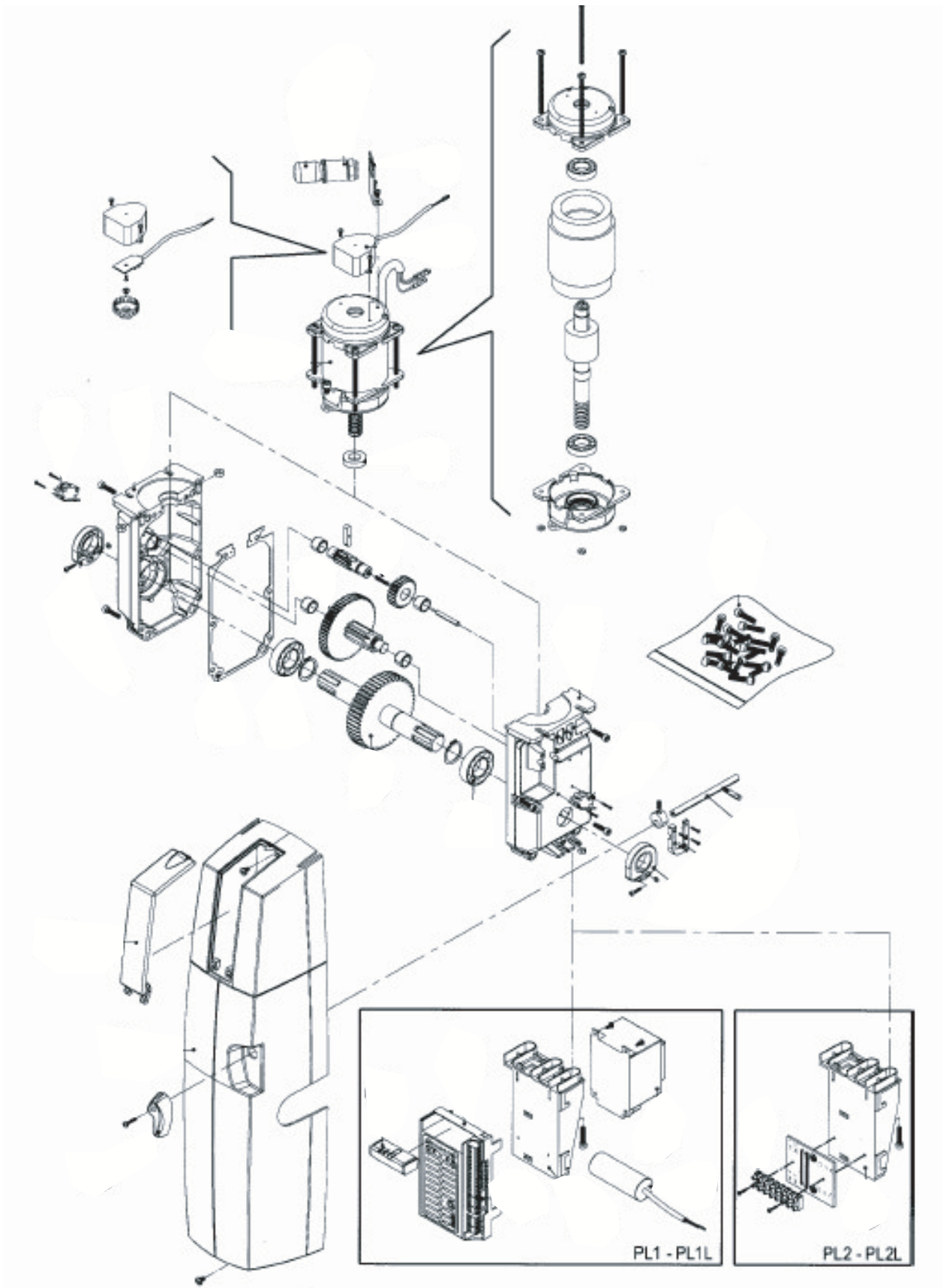

	<b>5RI1450000</b>	
	<b>5RI1340000</b>	
	<b>5RI1350000</b>	
	<b>5RI1360000</b>	
	<b>5RI1370000</b>	
	<b>5RI1380000</b>	
	<b>5RI1390000</b>	
	<b>5RI1400000</b>	
	<b>5RI1430000</b>	
	<b>5RI1470000</b>	
	<b>1AH0190000</b>	
	<b>1AH0180000</b> AGEMIDL	

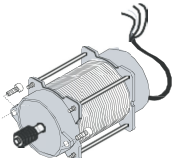
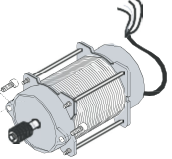

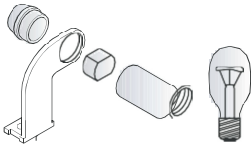
# PLUS

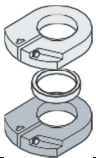
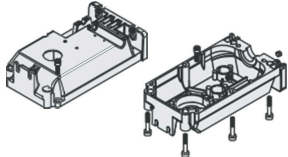
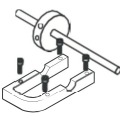
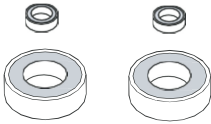

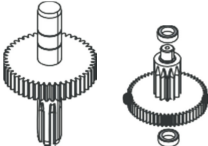
	<b>5RI0760000</b> PL1/PL2	
	<b>5RI0770000</b> PL1L/PL2L	
	<b>5RI1810000</b>	
	<b>5RI0740000</b>	
	<b>5RI0800000</b>	
	<b>5RI0730000</b>	
	<b>5RI0780000</b>	
	<b>5RI0810000</b>	
	<b>5RI0840000</b>	
	<b>5RI1970000</b>	
	<b>5RI0830000</b>	

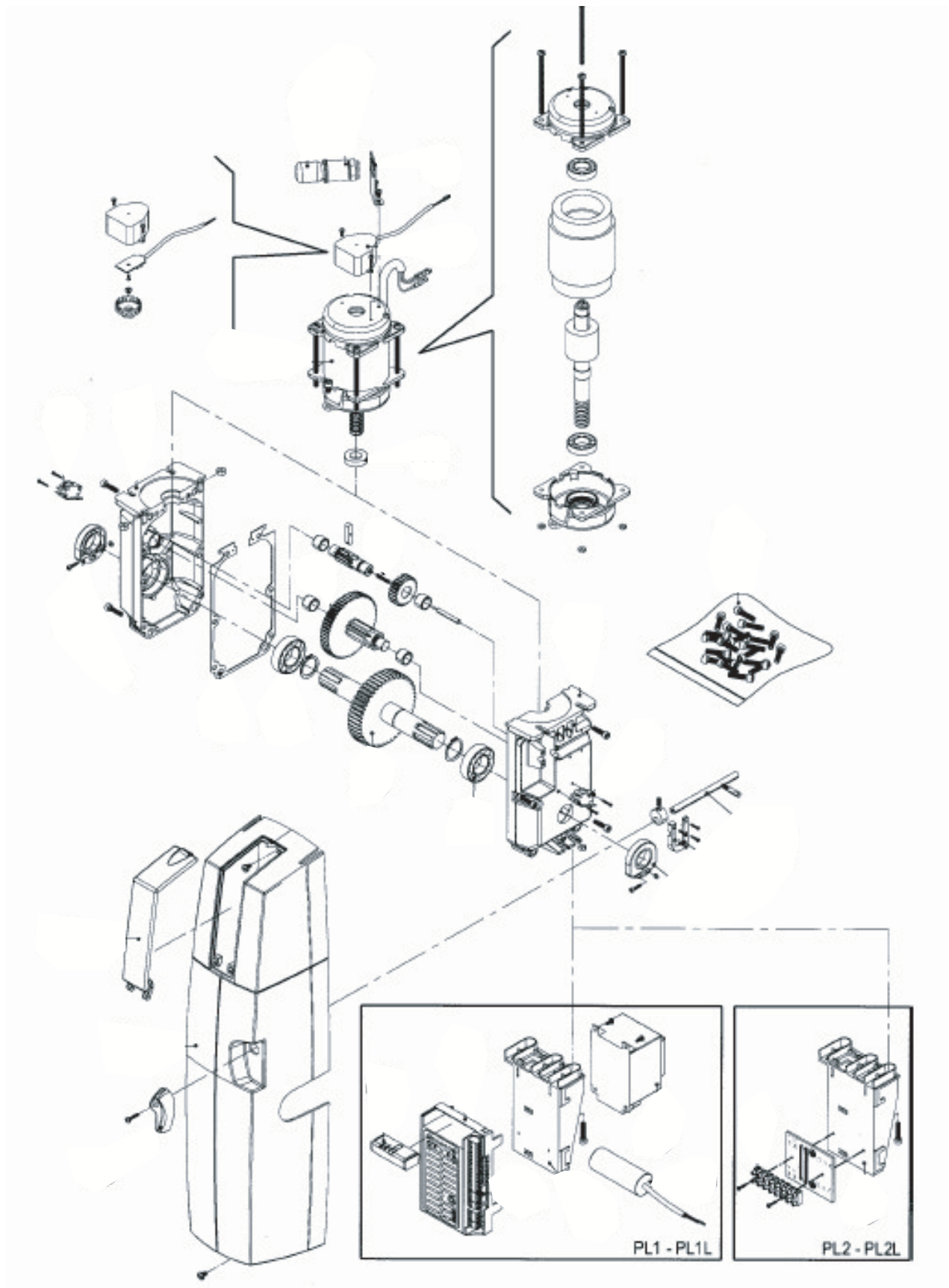

	<b>5RI3460000</b>	
	<b>5RI0720000</b>	
	<b>5RI0710000</b>	
	<b>5RI2690000</b>	
	<b>1AH0030100</b>	
	<b>5RI2580000</b>	
	<b>1AH0010000</b> AGEM1	

# PROBO

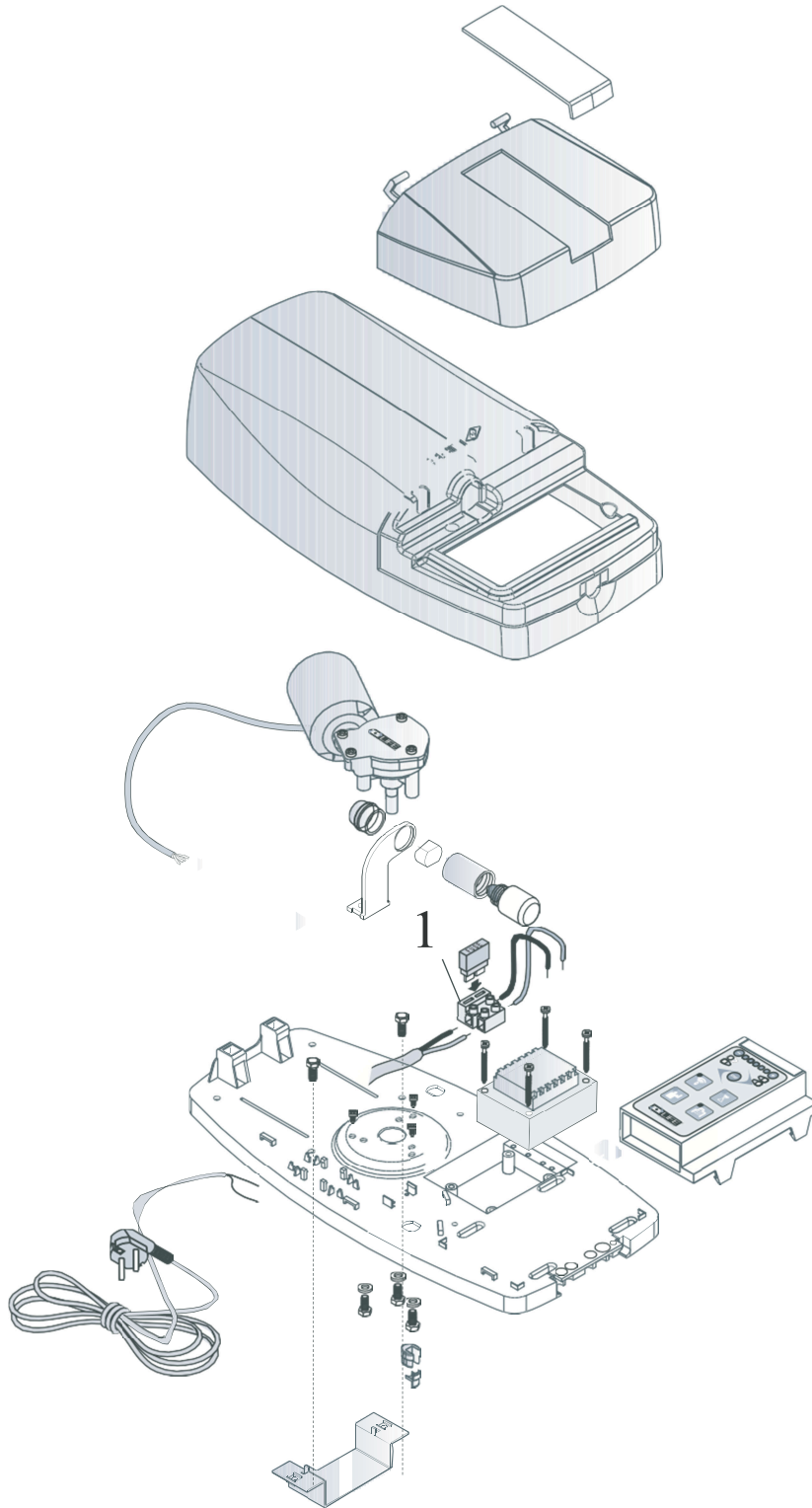

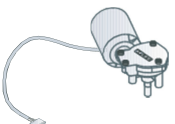
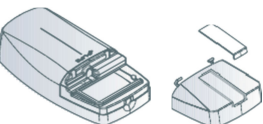
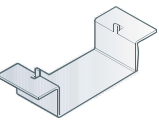
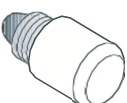
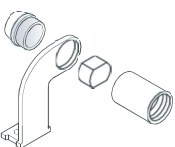
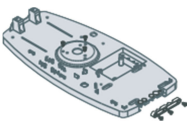
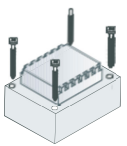
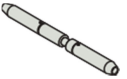
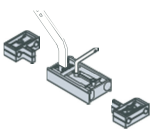
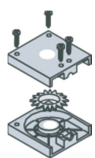
	<b>5RI1160000</b> <b>5RI1170000 PR120</b>	
	<b>5RI1130000</b>	
	<b>5RI1120000</b>	
<b>5 ;</b> 	<b>5RI2000000</b>	
	<b>5RI1150000</b>	
	<b>5RI1140000</b>	
	<b>5RI2840000</b> <b>5RI2850000 PR120 DL</b>	
	<b>5RI1580000</b>	
	<b>5RI1590000</b>	
	<b>5RI1610000</b>	
	<b>5RI1640000</b>	

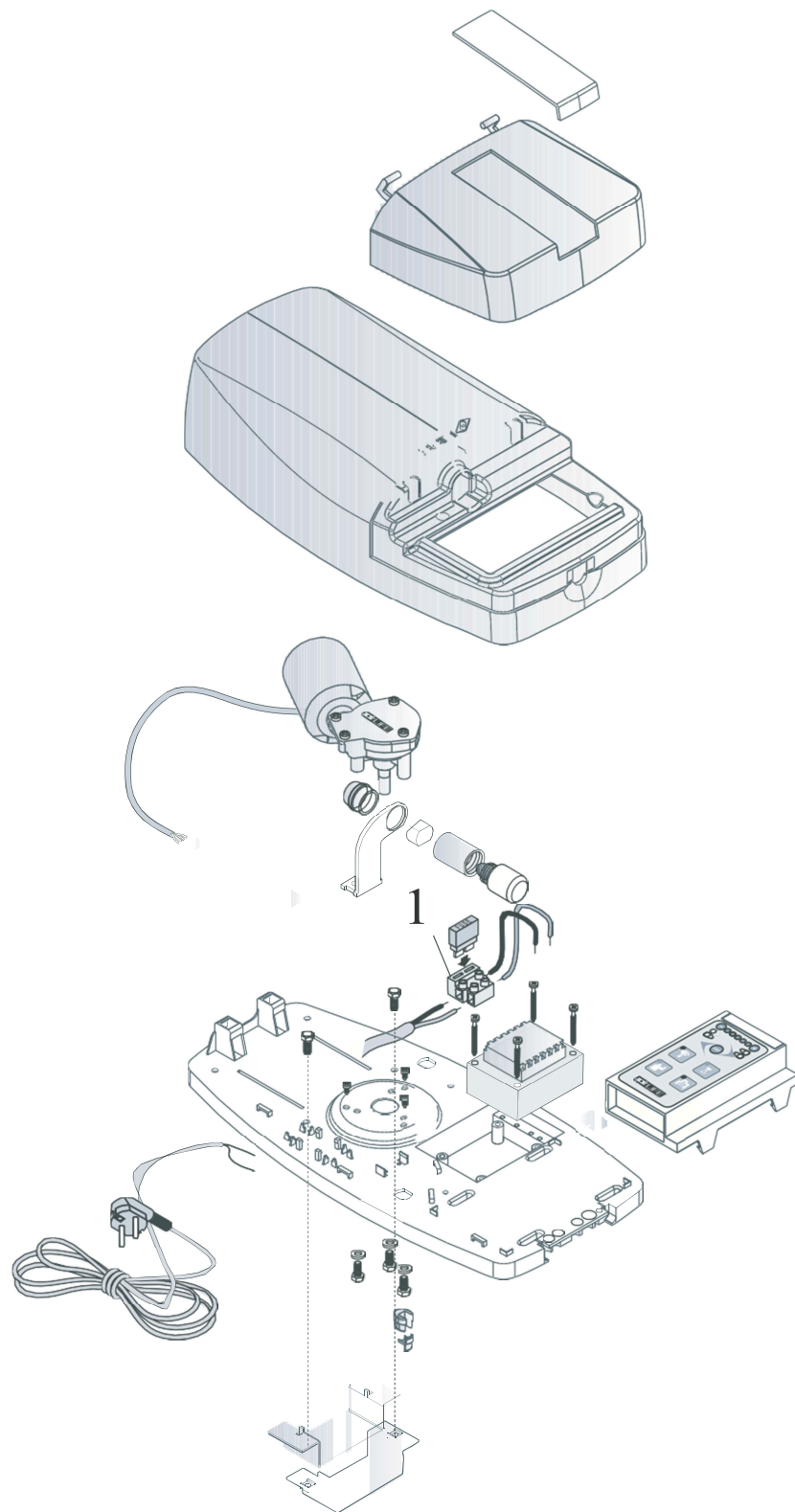

	<b>5RI1630000</b>	
	<b>5RI1600000</b>	
	<b>5RI1620000</b>	
	<b>5RI1690000</b>	
	<b>5RI1670000</b>	
	<b>5RI1660000</b> <b>5RI1650000</b>	
	<b>5RI1680000</b>	
	<b>5RI1190000</b> <b>5RI1200000</b> <b>5RI1210000</b>	
	<b>5RI1180000</b> <b>5RI1220000</b> <b>5RI1230000</b>	
	<b>1AH0150000</b> <b>1AH0150100 PR120</b>	
	<b>1AH0180000</b>	

# GEUNI R /GEUNIRS DL – GE2R



	<b>1AB0060000</b> GEBOX	
	<b>5RI1890000</b>	
	<b>1AH0110000</b> RGUNIR	
	<b>1AH0130000</b> RG2R	
	<b>1AH0110001</b> RGUNIR DL + AGEM 1 DL	
	<b>1AH0010000</b> AGEM1	
	<b>1AH0180000</b> AGEM1 DL	



# GE1 A/ GE2 A



	<b>1AB0060000</b> GEBOX	
	<b>5RI2690000</b>	
	<b>1AH0030100</b> RG1A	
	<b>1AH0040100</b> RG2A	
	<b>1AH0010000</b> AGEM (RG1A)	
	<b>1AH0020000</b> AGEM2 (RG2A)	

# GEUNI24R DL – GEUNI24R DL 1

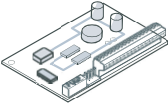
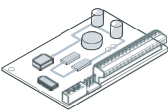

	<b>1AB0060000</b> GEBOX	
	<b>5RI2150000</b>	
	<b>1AH0170000</b> RGUNI24RDL+AGEM1 DL	
	<b>1AH0210000</b> RGUNI24RDL1+AGEM1 DL	
	<b>1AH0180000</b> AGEM1 DL	

# GE1 A 24 / GE2 A 24



	<b>1AB0060000</b> GEBOX	€ ,00
	<b>5RI2720000</b> GE2A24	€ ,00
	<b>5RI1870000</b> GE1A24	€ ,00
	<b>1AH0050100</b> RG1A 24	€ ,00
	<b>1AH0060100</b> RG2A 24	€ ,00
	<b>1AH0010000</b> AGEM1	€ ,00
	<b>1AH0020000</b> AGEM2	€ ,00



**MANASSIST - Manutenção e Reparação de Portas, Lda.**

**RUA CIDADE DE NAMPULA N° 148, LOJAS L/M**

**OLIVAIS**

**1800-105 LISBOA**

TELEFONE: **+ 359 218 530 058**

SITE [www.manassist.pt](http://www.manassist.pt)

E\_mail [info@manassist.pt](mailto:info@manassist.pt) / [comercial@manassist.pt](mailto:comercial@manassist.pt)

